

KLT-Y3MF-OV9281 V1.0

1MP OmniVision OV9281 Global Shutter MIPI Interface Fixed Focus Camera Module



Front View



Back View

Specifications

Camera Module No.	KLT-Y3MF-OV9281 V1.0
Resolution	1MP
Image Sensor	OV9281 Global Shutter
Sensor Type	1/4"
Pixel Size	3.0 um x 3.0 um
EFL	1.75 mm
F.NO	2.00
Pixel	1296 x 816
View Angle	160.0°(DFOV) 131.0°(HFOV) 80.0°(VFOV)
Lens Dimensions	10.00 x 10.00 x 12.82 mm
Module Size	21.60 x 10.00 mm
Module Type	Fixed Focus
Interface	MIPI
Auto Focus VCM Driver IC	None
Lens Model	KLT-LENS-TRC-4175B6
Lens Type	650nm IR Cut
Operating Temperature	-30°C to +85°C
Mating Connector	BBR43-30KB533



KLT-Y3MF-OV9281 V1.0

**1MP OmniVision OV9281 Global Shutter MIPI Interface
Fixed Focus Camera Module**



Top View

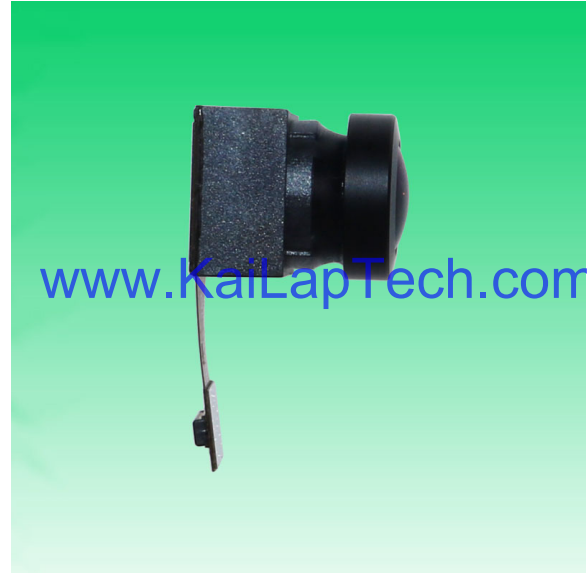

Side View

www.KaiLapTech.com

www.KaiLapTech.com

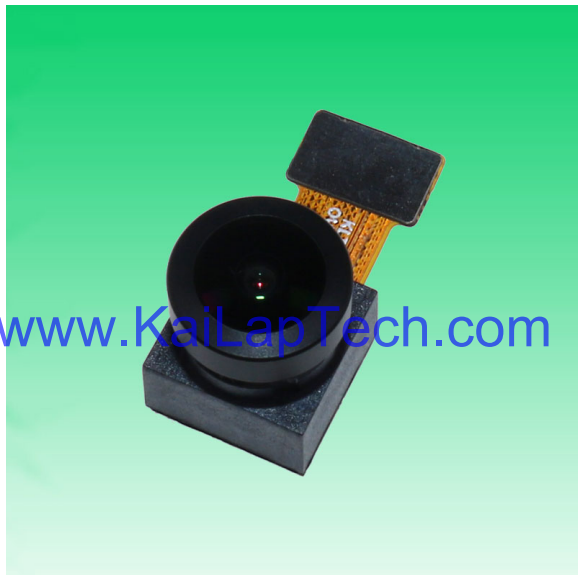

Bottom View



Mating Connector

Version		Information		Date	
V1.0	First Version			7-10-2021	

Pin No.	SIGNAL
1	GND
2	GND
3	GND
4	GND
5	NC
6	NC
7	SDA
8	DOVDD 1.8V
9	SCL
10	DVDD 1.2V
11	GND
12	XSHUTDOWN
13	MCN
14	NC
15	MCP
16	GND
17	MIDN0
18	XVCLK
19	MIDP0
20	SID
21	MIDN1
22	STROBE
23	MIDP1
24	AVDD 2.8V
25	NC
26	AGND
27	NC
28	NC
29	NC
30	NC

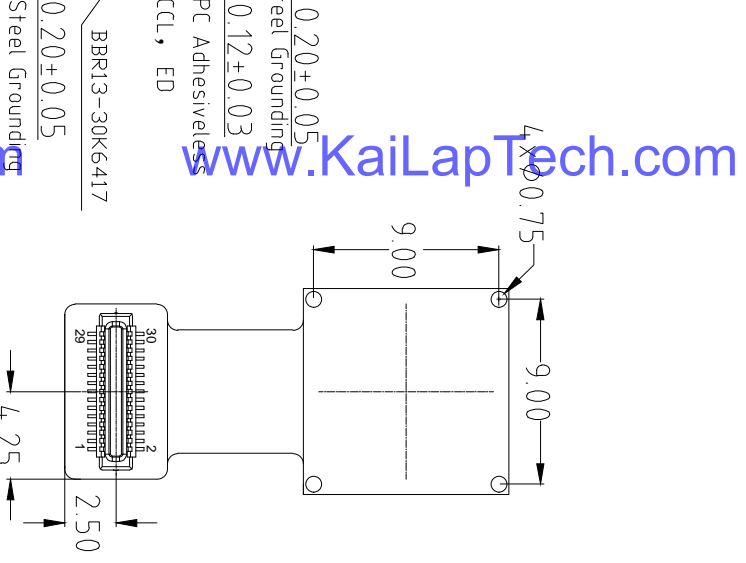
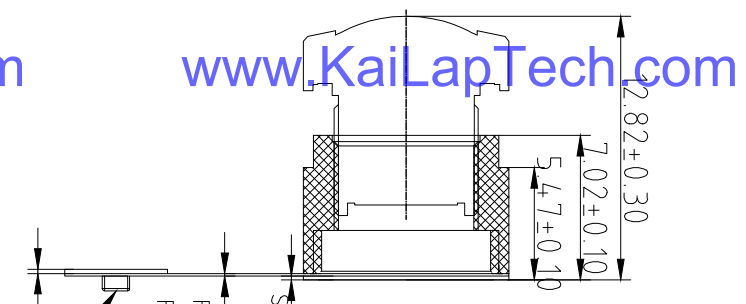
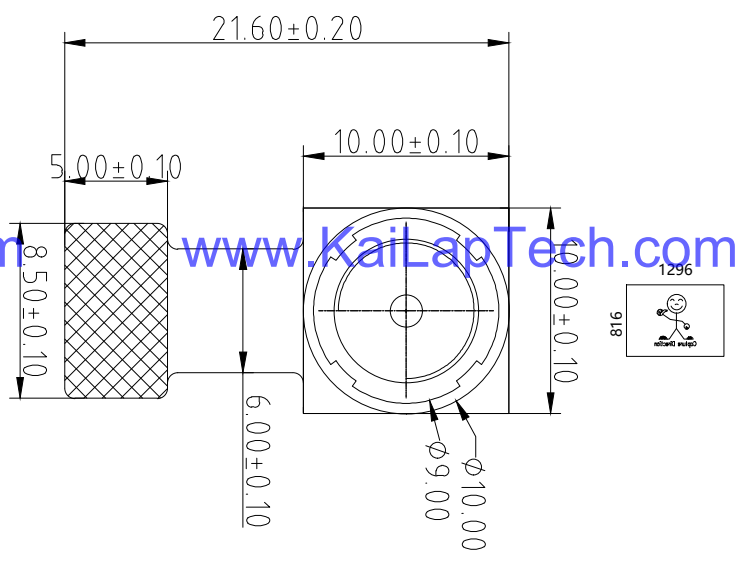

NOTE:
 1.Sensor I2C slave address:
 0xC0 If SID=0; or 0x20 If SID=1

Parameters:

1、Sensor specification:

Image Sensor: 0V9281
 Pixel: 3umx3um
 Lens Type: 1/4
 Important Voltage Description: DVDD1.2V
 (external power supply);

2、Lens specification:

F0V: 160°(D);131°(H);80°(V)
 F/No: 2.0
 TV Distortion: <-21%
 Focal length: 1.75mm
 Composition: 2G+4P+IR FILTER
 IR Cut Coating: 650nm±10nm@50%

Kai Lap Technologies Group Ltd

Designed By

Kevin

Model Name:

KLT-Y3MF-0V9281 V1.0

Checked By

Aouly_Yan

Projection Type:

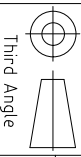

Unit: mm
 Scale: 1:1

Material:

Sheet: 1 of 1

Version: 1/0

1 2 3 4 5 6 7 8

REV.	EC#	DESCRIPTION	DATE	DRAWN	CHECKED	APPROVED
A	TJECR10018-02	NEW RELEASE PER NPRI0009	11/05/10	RAIN	DICK, SON	HARDWARE
B	TJECR13014	AXI, AXI	05/13/13	RAIN	SteveM	eng
						Jeff

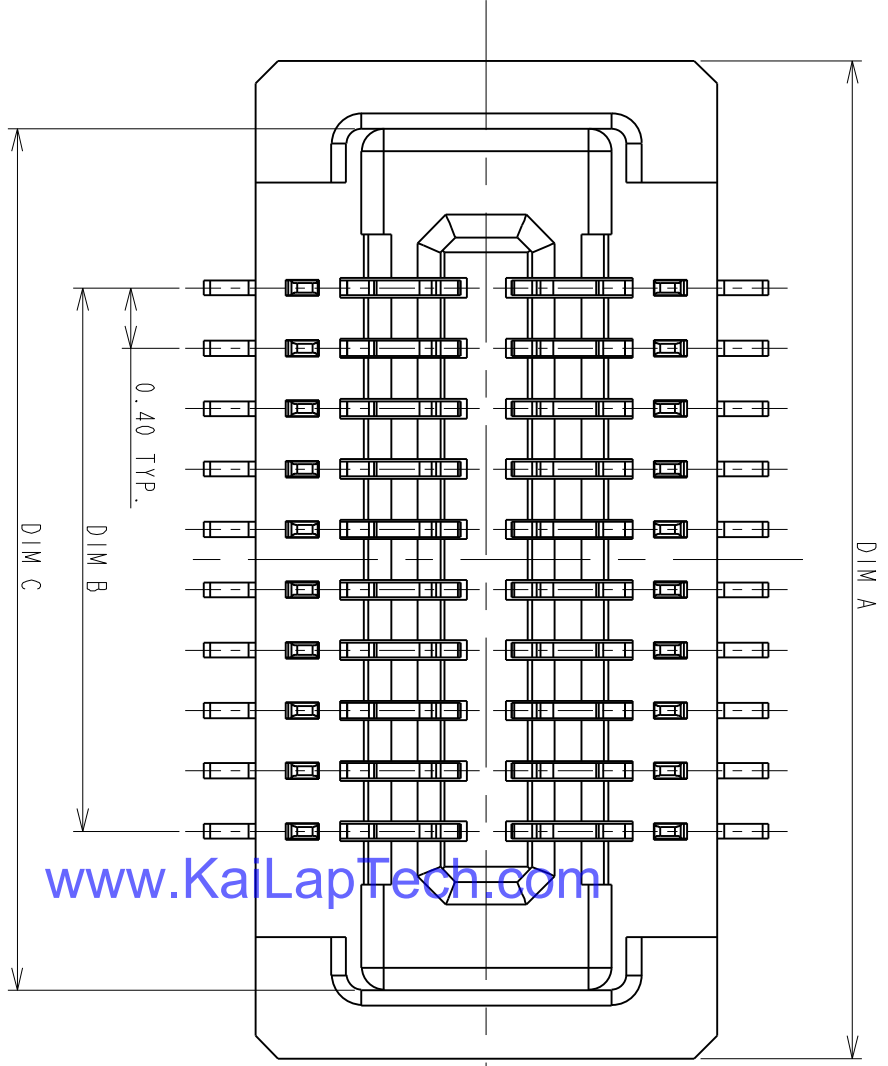

www.KaiLapTech.com

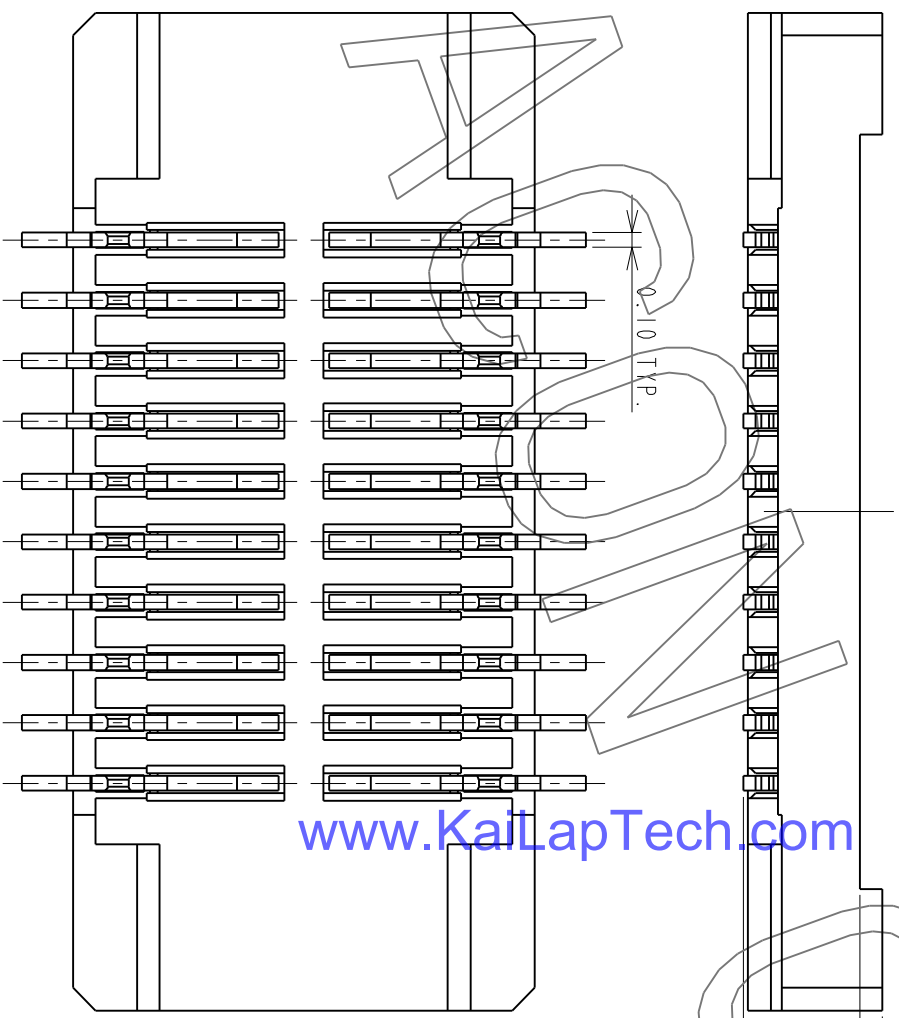

www.KaiLapTech.com

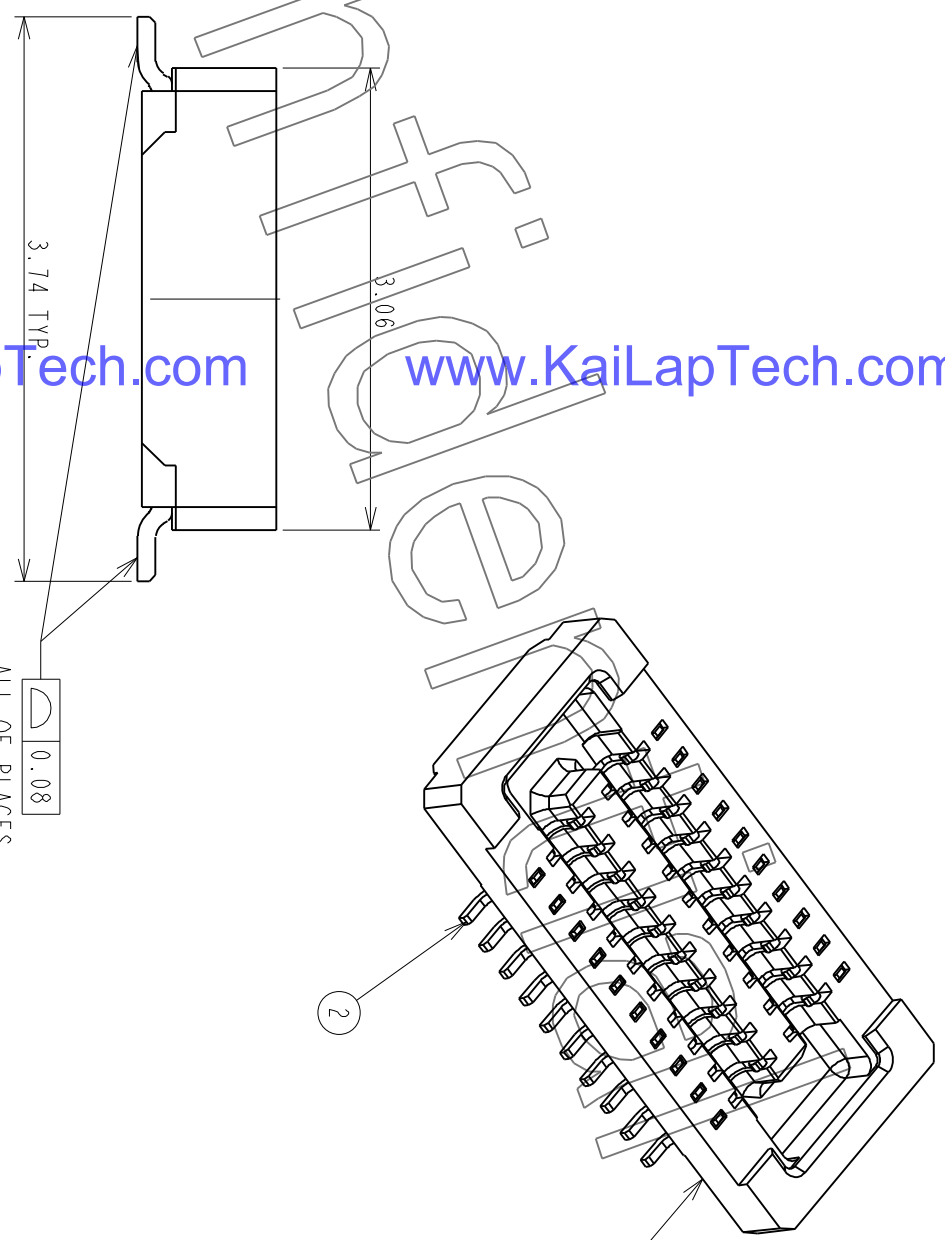

www.KaiLapTech.com

www.KaiLapTech.com

ITEM	NAME	Q'TY	PART #	MATERIAL / FINISH
2	CONTACT	XX	T-BBR43-100X30	COPPER ALLOY/PLATING GOLD
1	HOUSING	1	I-BBR43-1XXX33	HIGH TEMP RESIN/UL 94 V-0

TOLERANCES UNLESS OTHERWISE SPECIFIED	
GENERAL	±0.38
DESIGN	±0.25
RAIN	±0.05
CHECKED	DATE
HARDWARE	DATE
APPROVED	DATE
DICK, LEE	04/24/10

SCALE	20:1
SHEET	1 OF 2
UNIT	MM
CUSTOMER DRAWING	
SERIES	BBR
DWG NO.	C-BBR43-04-01
REV.	B



P0.4#11.0mm BOARD TO BOARD
CONN. RECEPTACLE
WITHOUT HOLD DOWN

This document and information contained herein are the property of Advanced Connectek Inc. Copies are issued in strict confidence and shall not be reproduced or copied, or used as the basis of manufacture or sale of apparatus without permission.

All materials meet the ACON's spec. environment-related substances management technical standard

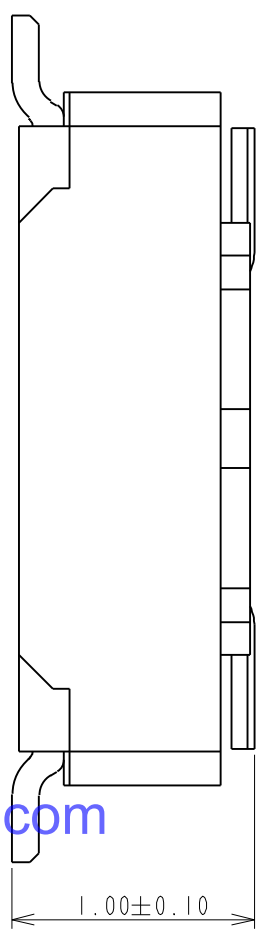

PRODUCT NUMBERING CODE:
 BBR43 - XX K X 5 X X
 1 2 3 4 5 6 7

1. PRODUCTION CODE:
 BBR43: BOARD TO BOARD 0.4 PITCH RECEPTACLE

2. POSITIONS:
 XX: POSITIONS(SEE TABLE A)

3. INSULATOR COLOR:
 K: BLACK

4. CONTACT PLATING:
 1: GOLD 10u" MIN
 2: GOLD 5u" MIN
 3: GOLD 10u" MIN
 B: GOLD 4u" MIN FOR SPOT PLATING
 ALL OVER: NI 50~100u"

5. TYPE OF HEIGHT:
 5: H=0.77mm

6. TYPE OF HOLD DOWN:
 3: WITHOUT HOLD DOWN

7. OTHER
 2: WITH POST, FINISHED PRODUCTS
 3: WITHOUT POST, FINISHED PRODUCTS

www.KaiLapTech.com

www.KaiLapTech.com

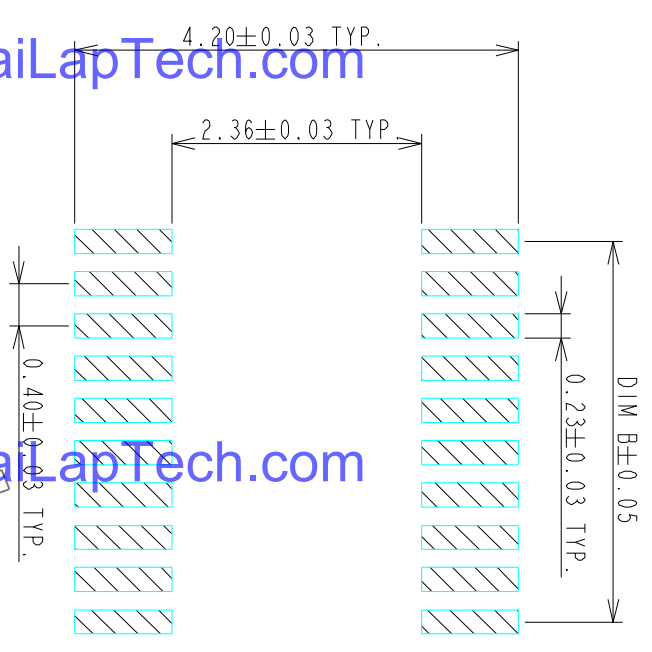

RECOMMENDED P.C. BOARD PATTERN DIMENSION (WITHOUT HOLD DOWN)

NOTES:
 1.0: RATING:
 1.1: VOLTAGE: 60V AC/DC
 1.2: CURRENT: 0.5 AMPS
 1.3: OPERATION TEMPERATURE: -40°C TO +85°C
 2.0: ELECTRICAL CHARACTERISTIC:
 2.1: CONTACT RESISTANCE: 50 mΩ MAX INITIAL
 2.2: INSULATION RESISTANCE: 1000 MΩ MIN INITIAL
 2.3: DIELECTRIC WITHSTANDING VOLTAGE: 250V AC FOR ONE MINUTE
 3.0 TOLERANCES UNLESS OTHERWISE SPECIFIED
 GENERAL: DIMENSION >10.00 ±0.13
 DIMENSION 5.00~10.00 ±0.10
 DIMENSION <5.00 ±0.05

4.0 ALL COPLANARITY IS 0.08mm MAX. BEFORE REFLOW
 ALL COPLANARITY IS 0.10mm MAX. AFTER REFLOW

www.KaiLapTech.com

www.KaiLapTech.com

TABLE A:

POSITIONS	DIM A	DIM B	DIM C
10	4.61	1.60	3.71
14	5.41	2.40	4.51
16	5.81	2.80	4.91
18	6.21	3.20	5.31
20	6.61	3.60	5.71
22	7.01	4.00	6.11
24	7.41	4.40	6.51
26	7.81	4.80	6.91
30	8.61	5.60	7.71
32	9.01	6.00	8.11
34	9.41	6.40	8.51
40	10.61	7.60	9.71
44	11.41	8.4	10.51
48	12.21	9.20	11.31
50	12.61	9.60	11.71
54	13.41	10.40	12.51
60	14.61	11.60	13.71
70	16.61	13.60	15.71
80	18.61	15.60	17.71

TOLERANCES UNLESS OTHERWISE SPECIFIED		DRAWN		DATE	
GENERAL X	±0.38	RAIN	04/15/10		
XXX	±0.13	DESIGN			
ANGLES X°	±0.05	RAIN	04/15/10		
SCALE	20:1	CHECKED			
SHEET	2 OF 2	HARDWARE	04/24/10		
UNIT	MM	APPROVED			
		DICK LEE	04/24/10		
		CUSTOMER DRAWING		TITLE	
				P0.4*H1.0mm BOARD TO BOARD	
				CONN. RECEPTACLE	
				WITHOUT HOLD DOWN	
		SERIES		SIZE	
		BBR		A3	
		DWG NO. C-BBR43-04-01		REV. B	

F

E

D

C

B

A

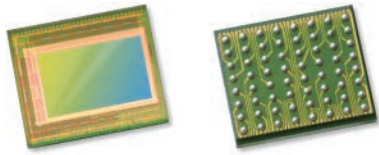

OV9281-OV9282 1-megapixel product brief



www.KaiLapTech.com

www.KaiLapTech.com

www.KaiLapTech.com

www.KaiLapTech.com

1-Megapixel OmniPixel®3-GS Sensors for Computer Vision Applications



available in a lead free package

OmniVision's OV9281 and OV9282 are high-speed global shutter image sensors that bring 1-megapixel resolution to a wide range of consumer and industrial computer vision applications, including augmented reality (AR), virtual reality (VR), collision avoidance in drones, bar code scanning and factory automation. Built on OmniVision's OmniPixel®3-GS pixel technology, the OV9281 and OV9282 feature a high-speed global shutter pixel with best-in-class near-infrared (NIR) quantum efficiency (QE) to meet high-resolution and low-latency requirements.

Special features of the OV9281 and OV9282 include region of interest (ROI) selection and context switching. This allows some of the camera settings to change dynamically as fast as alternating frames. The sensors are available in both narrow and wide chief ray angle (CRA) settings.

The 1/4-inch OV9281 and OV9282 capture 1280 x 800 resolution images at 120 frames per second (fps) and VGA resolution at 180 fps with 2-lane MIPI and DVP output. The OV9281 and OV9282 also feature support for frame synchronization and dynamic defective pixel correction.

The OV9281 has a chief ray angle (CRA) of 9 degrees and comes in a chip scale package (CSP). The OV9282 features a CRA of 27 degrees and is available in a reconstructed wafer (RW) format. Both sensors are currently available in volume production.

Find out more at www.ovt.com.



Applications

- Consumer HMD
- Drones
- Machine Vision
- PCNB

Product Features

- 3 μm x 3 μm pixel with OmniPixel³-GS technology
- automatic black level calibration (ABLC)
- programmable controls for:
 - frame rate
 - mirror and flip
 - cropping
 - windowing
- support output formats: 8/10-bit RAW
- fast modeswitching
- supports 2x2 monochrome binning
- two-lane MIPI serial output interface
- DVP parallel output interface
- supports horizontal and vertical 2:1 and 4:1 monochrome subsampling
- support for image sizes:
 - 1280 x 800
 - 1280 x 720
 - 640 x 480
 - 640 x 400
- embedded 256 bits of one-time programmable (OTP) memory for part identification
- two on-chip phase lock loops (PLLs)
- LED PWM
- built-in strobe control

OV9281-OV9282

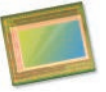

Ordering Information

- **OV9281-H64A**
(b&w, lead-free) 64-pin CSP
- **OV9282-GA4A**
(b&w, lead-free, 200 μm background, reconstructed wafer with good die)

Technical Specifications

- **active array size:** 1296 x 816
- **maximum image transfer rate:**
- 1280 x 800: 120 fps
- **power supply:**
 - analog: 2.8V (nominal)
 - core: 1.2V (nominal)
 - I/O: 1.8V (nominal)
- **power requirements:**
 - active: 156 mW
 - standby: 150 μA
 - XSHUTDOWN: 150 μA
- **temperature range:**
 - operating: -30°C to +85°C junction temperature
 - stable image: 0°C to +50°C junction temperature
- **output interfaces:** 2-lane MIPI serial output and DVP parallel output
- **output formats:** 8/10-bit RAW
- **lens size:** 1/4"
- **lens chief ray angle:**
 - OV9281: 9° linear
 - OV9282: 26.78° non-linear
- **scan mode:** progressive
- **pixel size:** 3 μm x 3 μm
- **image area:** 3896 μm x 2453 μm

Functional Block Diagram

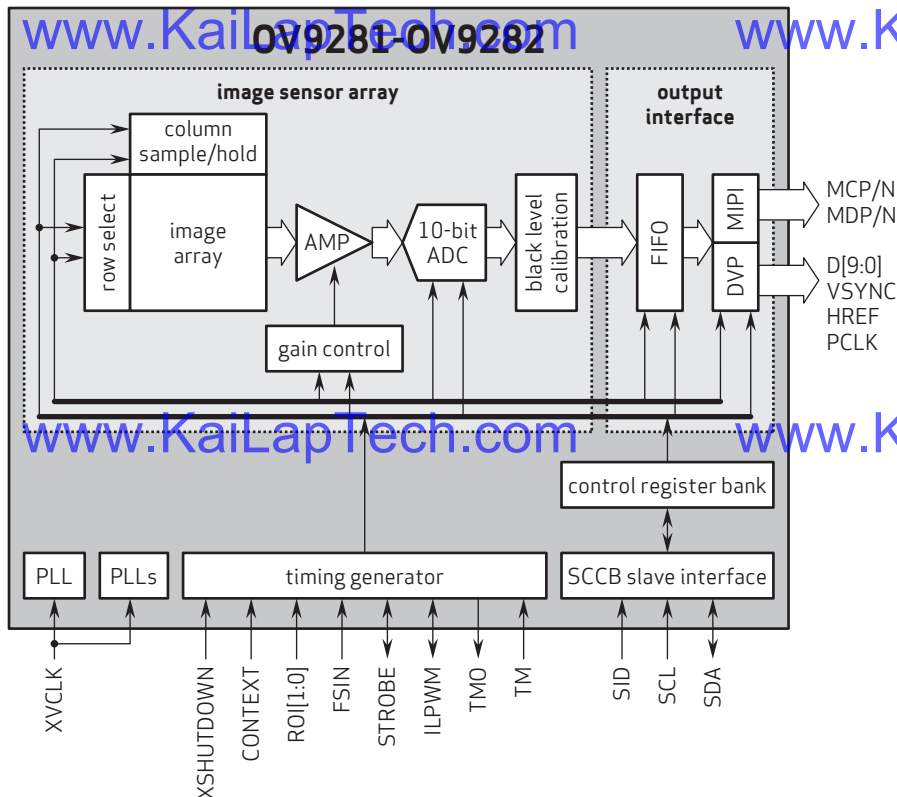

4275 Burton Drive
Santa Clara, CA 95054
USA

Tel: + 1 408 567 3000
Fax: + 1 408 567 3001
www.ovt.com

OmniVision reserves the right to make changes to their products or to discontinue any product or service without further notice. OmniVision, the OmniVision logo and OmniPixel are registered trademarks of OmniVision Technologies, Inc. All other trademarks are the property of their respective owners.



OmniVision



Camera Module Pinout Definition Reference Chart

OmniVision	Sony	Samsung	On-Semi	Aptina	Himax	GalaxyCore	PixArt	SmartSens	Sensors
Pin Signal		Description							
DGND GND		ground for digital circuit							
AGND		ground for analog circuit							
PCLK DCK		DVP PCLK output							
XCLR PWDN XSHUTDOWN STANDBY		power down active high with internal pull-down resistor							
MCLK XVCLK XCLK INCK		system input clock							
RESET RST		reset active low with internal pull-up resistor							
NC NULL		no connect							
SDA SIO_D SIOD		SCCB data							
SCL SIO_C SIOC		SCCB input clock							
VSYNC XVS FSYNC		DVP VSYNC output							
HREF XHS		DVP HREF output							
DOVDD		power for I/O circuit							
AFVDD		power for VCM circuit							
AVDD		power for analog circuit							
DVDD		power for digital circuit							
STROBE FSTROBE		strobe output							
FSIN		synchronize the VSYNC signal from the other sensor							
SID		SCCB last bit ID input							
ILPWM		mechanical shutter output indicator							
FREQ		frame exposure / mechanical shutter							
GPIO		general purpose inputs							
SLASEL		I2C slave address select							
AFEN		CEN chip enable active high on VCM driver IC							
MIPI Interface									
MDN0 DN0 MD0N DATA_N DMO1N		MIPI 1st data lane negative output							
MDP0 DP0 MD0P DATA_P DMO1P		MIPI 1st data lane positive output							
MDN1 DN1 MD1N DATA2_N DMO2N		MIPI 2nd data lane negative output							
MDP1 DP1 MD1P DATA2_P DMO2P		MIPI 2nd data lane positive output							
MDN2 DN2 MD2N DATA3_N DMO3N		MIPI 3rd data lane negative output							
MDP2 DP2 MD2P DATA3_P DMO3P		MIPI 3rd data lane positive output							
MDN3 DN3 MD3N DATA4_N DMO4N		MIPI 4th data lane negative output							
MDP3 DP3 MD3P DATA4_P DMO4P		MIPI 4th data lane positive output							
MCN CLKN CLK_N DCKN		MIPI clock negative output							
MCP CLKP MCP CLK_P DCKN		MIPI clock positive output							
DVP Parallel Interface									
D0 DO0 Y0		DVP data output port 0							
D1 DO1 Y1		DVP data output port 1							
D2 DO2 Y2		DVP data output port 2							
D3 DO3 Y3		DVP data output port 3							
D4 DO4 Y4		DVP data output port 4							
D5 DO5 Y5		DVP data output port 5							
D6 DO6 Y6		DVP data output port 6							
D7 DO7 Y7		DVP data output port 7							
D8 DO8 Y8		DVP data output port 8							
D9 DO9 Y9		DVP data output port 9							
D10 DO10 Y10		DVP data output port 10							
D11 DO11 Y11		DVP data output port 11							



your **BEST** camera module partner

Cameras Applications



www.KaiLapTech.com



www.KaiLapTech.com



www.KaiLapTech.com

www.KaiLapTech.com



www.KaiLapTech.com



www.KaiLapTech.com





Camera Reliability Test

Reliability Inspection Item		Testing Method	Acceptance Criteria	
Category	Item			
Environmental	Storage Temperature	High 60°C 96 Hours	Temperature Chamber	No Abnormal Situation
		Low -20°C 96 Hours	Temperature Chamber	No Abnormal Situation
	Operation Temperature	High 60°C 24 Hours	Temperature Chamber	No Abnormal Situation
		Low -20°C 24 Hours	Temperature Chamber	No Abnormal Situation
	Humidity	60°C 80% 24 Hours	Temperature Chamber	No Abnormal Situation
	Thermal Shock	High 60°C 0.5 Hours Low -20°C 0.5 Hours Cycling in 24 Hours	Temperature Chamber	No Abnormal Situation
Physical	Drop Test (Free Falling)	Without Package 60cm	10 Times on Wood Floor	Electrically Functional
		With Package 60cm	10 Times on Wood Floor	Electrically Functional
	Vibration Test	50Hz X-Axis 2mm 30min	Vibration Table	Electrically Functional
		50Hz Y-Axis 2mm 30min	Vibration Table	Electrically Functional
		50Hz Z-Axis 2mm 30min	Vibration Table	Electrically Functional
Cable Tensile Strength Test	Loading Weight 4 kg 60 Seconds Cycling in 24 Hours	Tensile Testing Machine	Electrically Functional	
Electrical	ESD Test	Contact Discharge 2 KV	ESD Testing Machine	Electrically Functional
		Air Discharge 4 KV	ESD Testing Machine	Electrically Functional
	Aging Test	On/Off 30 Seconds Cycling in 24 Hours	Power Switch	Electrically Functional
	USB Connector	On/Off 250 Times	Plug and Unplug	Electrically Functional





Inspection Item		Inspection Method	Standard of Inspection	
Category	Item			
Appearance	FPC/ PCB	Color	The Naked Eye	Major Difference is Not Allowed.
		Be Torn/Chopped	The Naked Eye	Copper Crack Exposure is Not Allowed.
		Marking	The Naked Eye	Clear, Recognizable (Within 30cm Distance)
	Holder	Scratches	The Naked Eye	The Inside Crack Exposure is Not Allowed
		Gap	The Naked Eye	Meet the Height Standard
		Screw	The Naked Eye	Make Sure Screws Are Presented (If Any)
		Damage	The Naked Eye	The Inside Crack Exposure is Not Allowed
	Lens	Scratch	The Naked Eye	No Effect On Resolution Standard
		Contamination	The Naked Eye	No Effect On Resolution Standard
		Oil Film	The Naked Eye	No Effect On Resolution Standard
		Cover Tape	The Naked Eye	No Issue On Appearance.
	Function	Image	No Communication	Test Board
Bright Pixel			Black Board	Not Allowed In the Image Center
Dark Pixel			White board	Not Allowed In the Image Center
Blurry			The Naked Eye	Not Allowed
No Image			The Naked Eye	Not Allowed
Vertical Line			The Naked Eye	Not Allowed
Horizontal Line			The Naked Eye	Not Allowed
Light Leakage			The Naked Eye	Not Allowed
Blinking Image			The Naked Eye	Not Allowed
Bruise			Inspection Jig	Not Allowed
Resolution			Chart	Follows Outgoing Inspection Chart Standard
Color			The Naked Eye	No Issue
Noise			The Naked Eye	Not Allowed
Corner Dark			The Naked Eye	Less Than 100px By 100px
Color Resolution			The Naked Eye	No Issue
Dimension	Height	The Naked Eye	Follows Approval Data Sheet	
	Width	The Naked Eye	Follows Approval Data Sheet	
	Length	The Naked Eye	Follows Approval Data Sheet	
	Overall	The Naked Eye	Follows Approval Data Sheet	



KLT Package Solutions

KLT Camera Module



Complete with Lens Protection Film



Tray with Grid and Space



Place Cameras on the Tray





Camera Modules Package Solution

Full Tray of Cameras



Cover Tray with Lid



Put Tray into Anti-Static Bag



Vacuum the Anti-Static Bag

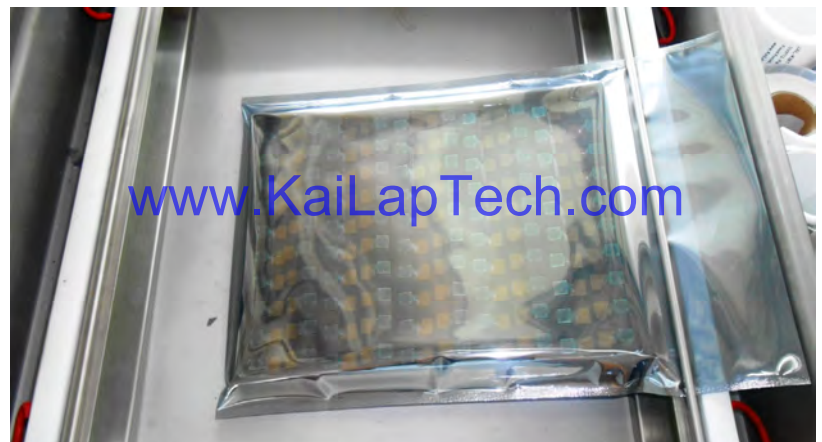



Camera Modules Package Solution

Sealed Vacuum Bag with Labels

- 1. Model and Description 2. Quantity 3. Shipping Date 4. Caution**





CMOS CAMERA MODULES



your BEST camera module partner

Large Order Package Solution

Place Foam Sheets Between Trays

Foam Sheets are Slightly Larger than Trays



www.KaiLapTech.com

www.KaiLapTech.com

Place Foam Sheets and Trays into Box

Foam Sheets are Tightly Fitting Box

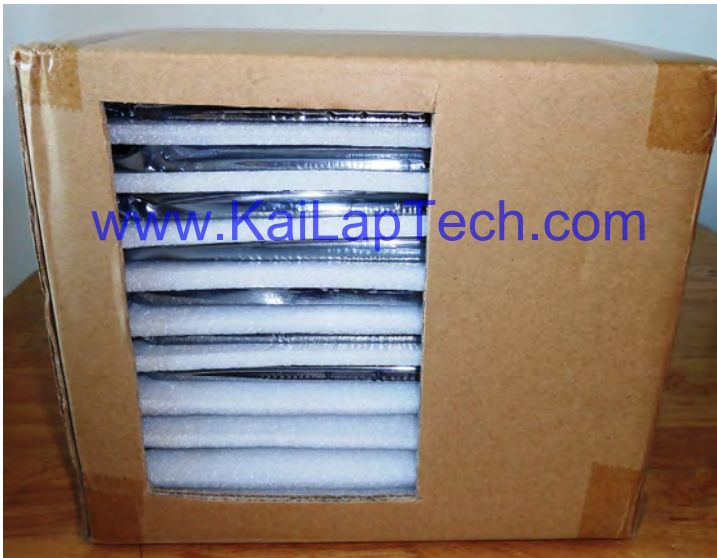

www.KaiLapTech.com sales@KaiLapTech.com Tel: (852) 6908 1256 Fax: (852) 3017 6778

All rights reserved @ Kai Lap Technologies Group Ltd. Specifications subject to change without notice.



CMOS CAMERA MODULES



your BEST camera module partner

Small Order Package Solution

Place Foam Sheets and Trays into Small Box



www.KaiLapTech.com

Package in Small Box for Shipment

Foam Sheets are Nicely Fitting the Small Box



www.KaiLapTech.com

Place Small Boxes into Larger Box



www.KaiLapTech.com sales@KaiLapTech.com Tel: (852) 6908 1256 Fax: (852) 3017 6778

All rights reserved @ Kai Lap Technologies Group Ltd. Specifications subject to change without notice.

Carbon Box Package Solution

Seal the Carbon Box

Final Package Labelled Box



Carbon Box Ready for Shipment

1. Delivery Address and Phone No.
2. Box No. and Ship Date
3. Fragile Caution





Sample Order Package Solution

Place Sample into Small Anti-Static Bag



Place Connectors into Small Ant-Static Bag



Sample Labels on the Small Bag

1. Camera Module or Connector Model 2. Shipping Date and Quantity 3. Caution





Connectors Large Order Package Solution

Connectors in a Wheel



Label Connectors in the Wheel



The Wheel is Perfectly Fitting the Box



Connectors Box Ready for Shipment



Company Kai Lap Technologies (KLT)

Kai Lap Technologies Group Limited. (KLT) was established in 2009, a next-generation technology driven manufacturer specialized in research, design, and produce of audio and video products. KLT is occupying 20,000 square feet automated plants with 100 employees of annual throughput 30,000,000 units cameras.

KLT provides OEM, ODM design, contract manufacturing, and builds the camera products. You may provide the requirements to us, even with a hand draft, our sales and engineering work together to meet your needs. We consider ourselves your last-term partner in developing practical and innovative solutions.

Our team covers everything from initial concept development to mass produced product. KLT specializes in customized camera design, raw material, electronic engineering, firmware/software development, product testing, and packing design. Our experienced strategic supply systems offer a robust and dependable manufacturing capacity for orders of various sizes.

www.KaiLapTech.com

www.KaiLapTech.com



Limited Warranty

KLT provides the following limited warranty if you purchased the Product(s) directly from KLT company or from KLT's website, www.KaiLapTech.com. Product(s) purchased from other sellers or sources are not covered by this Limited Warranty. KLT guarantees that the Product(s) will be free from defects in materials and workmanship under normal use for a period of one (1) year from the date you receive the product ("Warranty Period").

For all Product(s) that contain or develop material defects in materials or workmanship during the Warranty Period, KLT will, at its sole option, either: (i) repair the Product(s); (ii) replace the Product(s) with a new or refurbished Product(s) (replacement Product(s) being of identical model or functional equivalent); or (iii) provide you a refund of the price you paid for the Product(s).

This Limited Warranty of KLT is solely limited to repair and/or replacement on the terms set forth above. KLT is not reliable or responsible for any subsequent events.





CMOS CAMERA MODULES



your BEST camera module partner

KLT Strength

Powerful Factory



www.KaiLapTech.com

www.KaiLapTech.com

Professional Service



www.KaiLapTech.com

www.KaiLapTech.com

Promised Delivery



www.KaiLapTech.com

www.KaiLapTech.com

www.KaiLapTech.com sales@KaiLapTech.com Tel: (852) 6908 1256 Fax: (852) 3017 6778

All rights reserved @ Kai Lap Technologies Group Ltd. Specifications subject to change without notice.